

LO[®]

LO[®] Cockpit[®]

Product information sheet



Product range

The more agile the working method, the more nimble the office furniture needs to be. LO Cockpit safely guides project teams looking for quick success on the way to new solutions. LO Cockpit two model variants – Basic and Plus – meet the needs of the new working world. Flexibility guaranteed regardless of whether you choose a horizontally fixed worktop or a swivelling worktop with whiteboard.



800 mm



1200 mm

800 mm

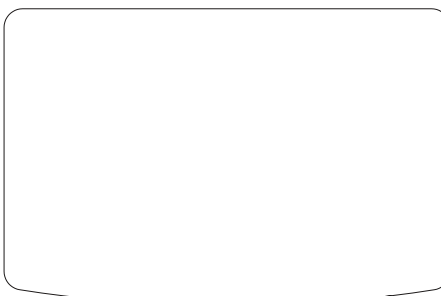

1200 mm

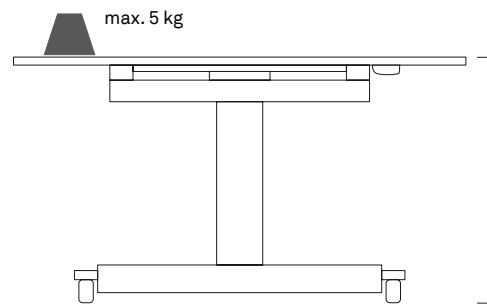

Adjustment range LO Cockpit Basic: 675 - 1335 mm
Adjustment range LO Cockpit Plus with
table top unfolded: 1170 - 1830 mm

Product range

The organic shape of the mobile table encourages brainstorming while sitting or standing – adjustable height from 675 to 1335 millimeters. The height can be adjusted using a pneumatic drive – no power required. In addition, the LO Cockpit is also available in a rectangular panel shape.



Details

The versatile table features castors to allow for quick and frequent location changes. Park the LO Cockpit and save space with its slanted feet.

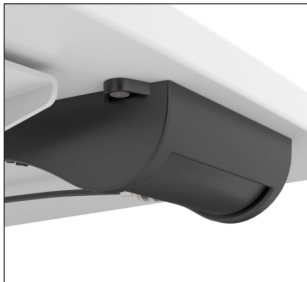

Stepless height adjustment



Handle for tilt mechanism



Lockable castors



Stackable



Table top folded up



Whiteboard



Magnetic whiteboard

Details

LO Cockpit remains flexible whether with legroom trim or individual electrification with magnetic plug boxes.



Legroom trim



Plug boxes

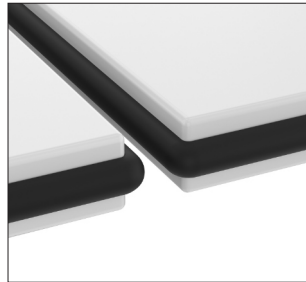

Bumper (optional)

Details

An assortment of privacy screens and organisational elements is available to help boost concentration, tidiness and individuality. LO Cockpit can be easily extended using the following compatible LO Extend elements. Please note that these organiser elements are only available for the existing LO Cockpit and not for LO Cockpit Basic & Plus.



Privacy screen "formfleece"



Privacy screen "screen"
750/950

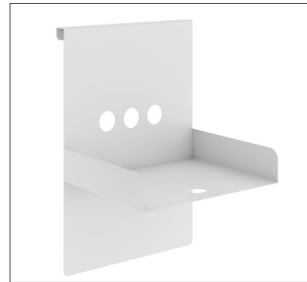

A4 horizontal tray

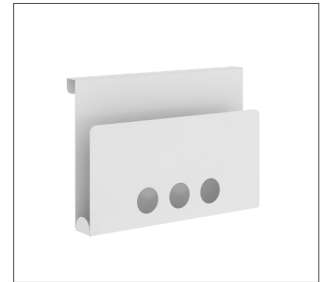

A4 vertical tray

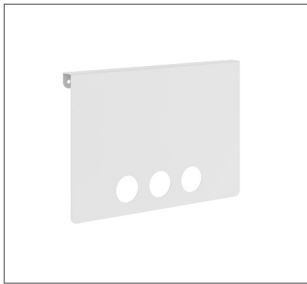

Magnetic panel, small /
Magnetic panel, large

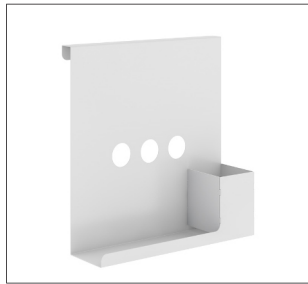

Pen tray

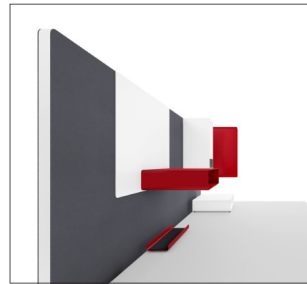

Privacy screen "function"



Cable guide vertical



Cable sleeve

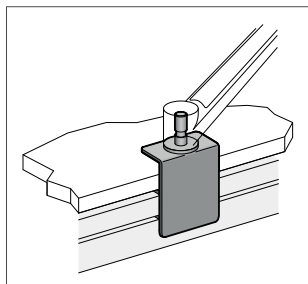

Adapter for monitor arm

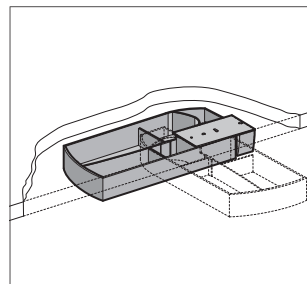

Pencil tray traversable

Warranty

LOG Produktions AG guarantees Lista Office LO products for five years from delivery ex works. A two-year warranty period applies to the motor systems used in the product ranges LO Manus and LO Cockpit. All other bought-in parts used in our own products (such as textiles, glass components, etc.) and/or pneumatic components (motors) are guaranteed for two years from the date of delivery. Replaces all previous price lists. We reserve the right to make changes to the prices, designs and dimensions of products. LOG Produktions AG is certified in accordance with ISO 9001 and ISO 14001.

You can find care and maintenance instructions for your product on our home page. You can find information on how to assemble and use your product in the user manual.



Version

Version 1.0, August 2023 (date created)

Version 1.1, January 2024 (Removal of the colours)

Lista Office LO
LOG Produktions AG
Alfred Lienhard Strasse 2
9113 Degersheim
Switzerland

Telephone +41 71 372 52 52
Hotline 0800 633 642
info@lista-office.com

www.lista-office.com